

**PLEASE READ MANUAL IT WOULD ALLOW YOU TO ENJOY YOUR POWERBOARD MORE**



**OWNER'S:  
MANUAL  
WARRANTY INFORMATION**

**ALWAYS WEAR A HELMET!!!  
PLEASE BE SAFE WHEN RIDING!!!**



Puzey Designed. Built 4 Lifestyle.

## TABLE OF CONTENTS:

<u>Description</u>	<u>Page</u>
<b>A. Table of Contents</b>	1
<b>B. Important!!!</b>	2
<b>C. Safety</b>	3
<hr/>	
<b>D. Getting to Know YOUR Powerboard</b>	4
<b>E. Package Contents</b>	5
<b>F. Getting Started</b>	5
<b>G. Folding and Storage</b>	7
<hr/>	
<b>H. Operating Procedures</b>	7
<b>I. Fuel Mixture Table</b>	8
<b>J. Maintenance</b>	8
Recommended Tools	8
Carburettor Adjustments	9
Cleaning the Airfilter	10
Braking System	11
Tyres and Wheels	11
Adjusting the Head Unit	12
Adjusting the Belt and Chain	13
Maintenance Schedule	14
<b>K. Other Questions</b>	14

**B.****IMPORTANT!!!****PLEASE READ THIS FIRST BEFORE OPERATING THIS PRODUCT****WHERE TO USE POWERBOARD:**

This product does not conform to Local Motor Vehicle Standards and is not intended for operation on public streets, roads or highways. Serious injury can result from the unsafe operations of this vehicle. Operators could minimize these risks by using certain safety equipment such as: safety helmet, goggles, gloves, elbow and kneepads and appropriate footwear.

**HOW TO USE THIS PRODUCT:**

DO NOT operate this product in traffic, on wet, frozen oily or unpaved surfaces or under the influence of drugs and/or alcohol. Avoid uneven surfaces, potholes, surface cracks and obstacles. This product is designed for paved or tared smooth flat surfaces. BE CAREFUL when riding this product in the rain or in wet conditions.

**CHECKS:**

It is the customer's responsibility to check all nuts and bolts (as per box) and ensure that the product is in a safe roadworthy condition at all times.

**WARNING!**

- Never let a child or inexperienced person operate this product!
- Never start the engine inside a closed room or building. Breathing exhaust fumes can be fatal.
- This product should not be used by persons without excellent vision, balance, co-ordination, reflex, muscle and bone strength and good decision-making capabilities.
- This product should not be used by minors without adult supervision.
- This product should not be used by persons unwilling or unable to take responsibility for their own actions.
- The user of this product assumes ALL risks associated with its use. To minimize these RISKS, the user must wear safety helmet, goggles, gloves, elbow and kneepads and appropriate footwear.



Indicates a strong possibility of personal injury or equipment damage if instructions are not followed.

## C. SAFETY

### Fuel Safety

- Mix and pour fuel outdoors away from sparks or flames.
- Use only a container approved for fuel.
- Do not smoke or allow smoking near the Powerboard while working on the engine, or while the engine is running.
- Wipe up and clean all fuel spills before starting the engine.
- Move at least 10 metres away from where you fuelled before starting the engine.
- Stop engine before removing the fuel cap.
- It is recommended that you empty the fuel tank prior to shipping or storage to prevent fuel leaks.
- Do not store your Powerboard near open flames, furnaces, electric motors or switches.

### Maintenance Safety

- Maintaining your Powerboard is recommended in this Owner's Manual.
- Disconnect the spark plug cap before performing any engine maintenance, except for carburettor adjustments.
- Keep others away while making carburettor adjustments.
- Use only quality replacement parts as recommended by the manufacturer.

### Transportation and Storage

- Carry your Powerboard by the handlebar tube with the engine turned off and the muffler away from your body.
- Allow the engine to cool, empty the fuel tank and fold the Powerboard before carrying or storage.
- It is recommended that you empty the fuel tank prior to shipping or storage to prevent fuel leaks.
- Clean the Powerboard carefully and store in a cool, dry place.

### Product Safety

- Keep hands and feet away from moving parts.
- Inspect the entire product prior to each use. Replace damaged parts. Check for fuel leaks and make sure all fasteners are in place and securely fastened.
- Replace all parts that are cracked, chipped or damaged before use.
- Use only parts and accessories that are recommended by the manufacturer.

***If a situation arises that is not covered in the manual,  
proceed with caution and use good judgement.***

**Contact your Powerboard Dealer if you need further assistance.**

## D. GETTING TO KNOW YOUR POWERBOARD

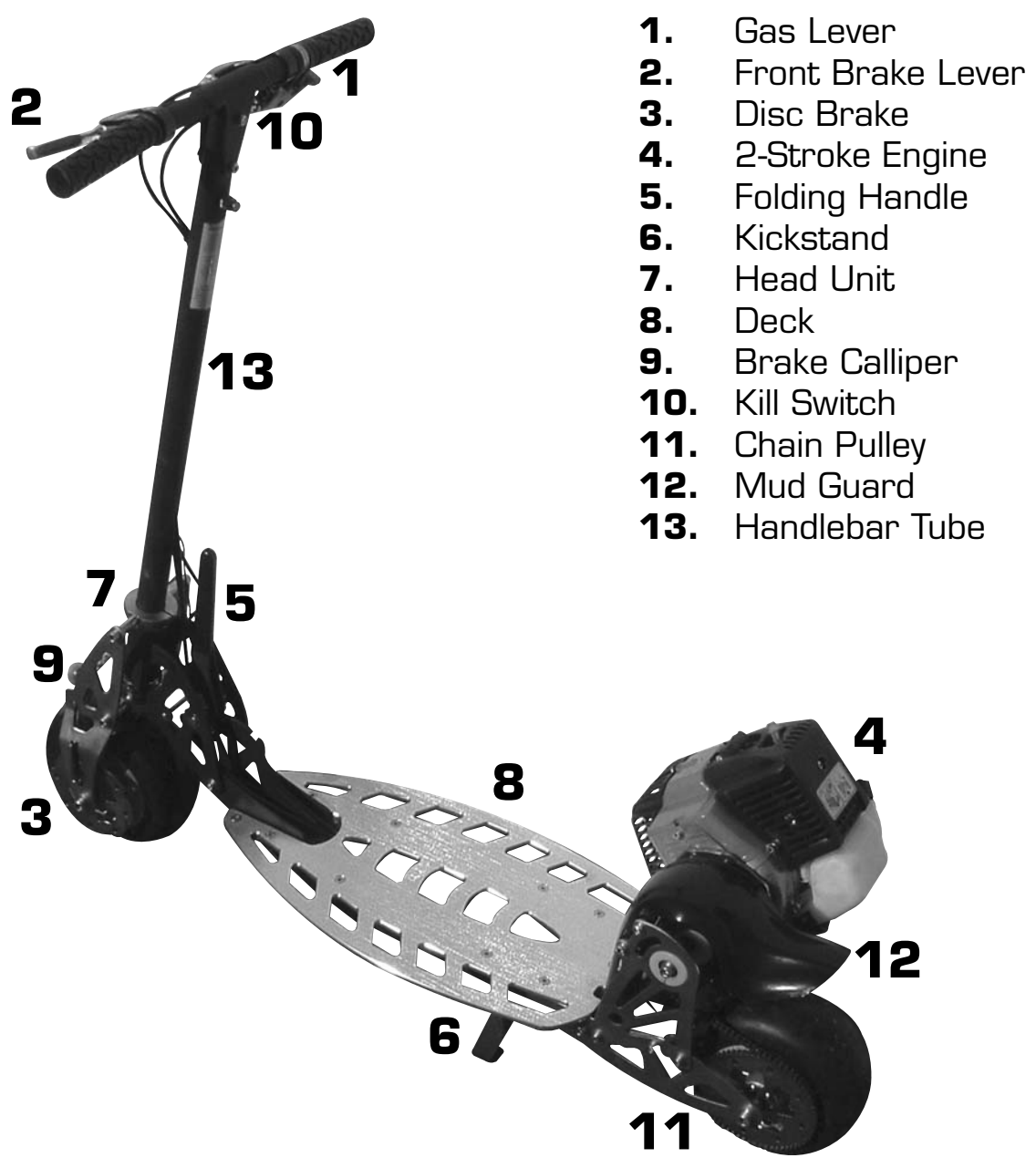

- 1. Gas Lever
- 2. Front Brake Lever
- 3. Disc Brake
- 4. 2-Stroke Engine
- 5. Folding Handle
- 6. Kickstand
- 7. Head Unit
- 8. Deck
- 9. Brake Calliper
- 10. Kill Switch
- 11. Chain Pulley
- 12. Mud Guard
- 13. Handlebar Tube

- 14. Recoil Starter
- 15. Gas Tank
- 16. Gas Cap
- 17. Choke Lever
- 18. Carburettor
- 19. Carburettor Cover
- 20. Muffler
- 21. Muffler Cover
- 22. Spark Plug

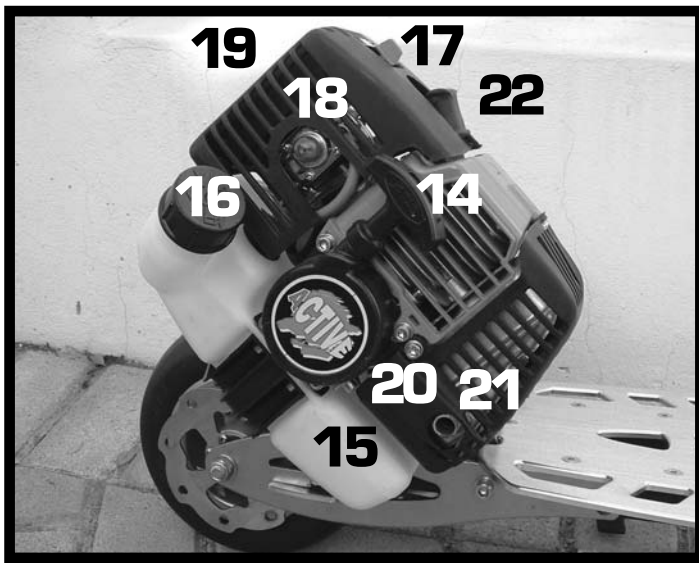

## E. PACKAGE CONTENTS

Your EVO Powerboard comes with the following items in the box.

Please locate all of the following:

1. The EVO Powerboard
2. Allen Wrench
3. Owner's Manual
4. Seat Post (Optional)

## F. GETTING STARTED

*Please read and understand these instructions and the OPERATING PROCEDURES section, prior to starting or riding your EVO Powerboard!*

### Unfolding



Fig. 1



Fig. 2

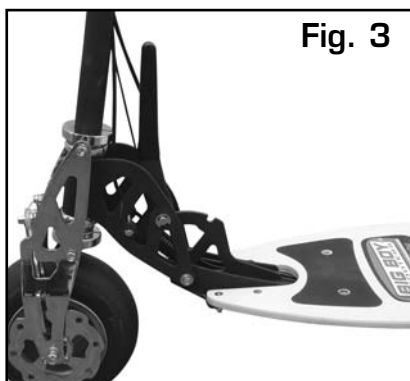

Fig. 3

1. Carefully remove the EVO Powerboard from the box.
2. To unfold the EVO Powerboard, begin by pressing down on the FOLDING HANDLE with one hand (Fig. 1), while gently pulling up on the handlebar post with the other (Fig. 2).
3. Fully extend the handlebar post to the upright position until you feel the mechanism lock into place (Fig. 3).
4. Detach the handlebar from the post and mount the handlebar onto the post using the bolts provided.
5. Adjust the Gas and Brake Levers using the provided Allen Wrench, loosen the tension bolt and adjust the levers to a comfortable position (Fig4).  
**\*BE CAREFUL NOT TO PULL ON THE CABLES AND ENSURE THEY ARE ROUTED THE SAME AS IN FIG 4!!!**

#### Fuelling

*This is a 2-stroke engine. Always run the engine using fuel, which is mixed with 2-cycle engine oil.*

**PLEASE READ OPERATING PROCEDURES BEFORE FUELLING!!**

6. Mix fuel (minimum 93 octane) and 2-cycle engine oil in separate container. Use between 40:1 and 60:1 oil mixture ratio depending on quality of fuel in your area. (Refer to Fuel Guide on page 8). Make sure the fuel is well mixed by shaking the container.
7. Make sure that the engine is off!
8. Slowly open the GAS CAP, so that possible over-pressure disappears.

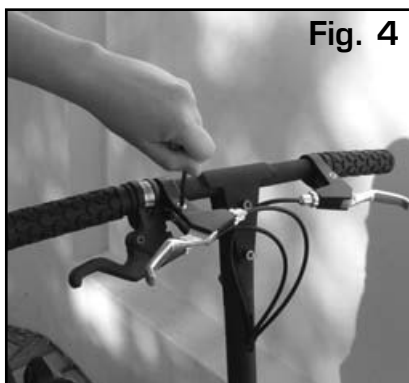

Fig. 4

9. Clean the tank cap area to make sure that it is free from excess dirt and debris.
  - \* **Make sure that no dirt falls into the gas tank!**
10. Pour pre-mixed Gas/Oil mixture into the GAS TANK. Tank capacity is 0.9 litres.
  - \* **Fill to below the Fuel Pipe entry plug, do not overfill.**
11. After fuelling, replace the GAS CAP and tighten. Ensure the cap is not cross threaded.

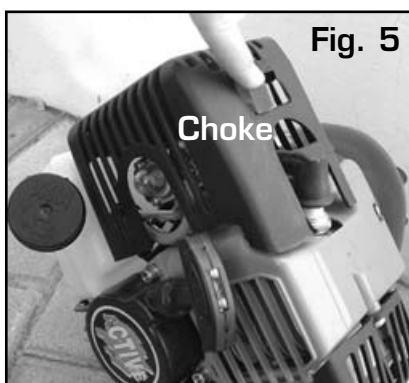

Fig. 5

Choke

### Starting

**Move at least 10 metres away from where you filled up with gas!!!**

12. Set the CHOKE LEVER to the CHOKED (UP) position (Fig. 5).
13. Pump the clear bulb to prime the Carburettor. It is primed when fuel is seen returning to the fuel tank.
14. Pull the RECOIL STARTER briskly, making sure to hold the handle in your grasp. (Fig 6).
  - \* **Note: Do not allow it to snap back, let it back slowly!**
15. Only use the choke system when the engine is cold, make sure NOT to pull the gas lever when pulling the pullstart. When starting a warm engine, do NOT use the choke system, but gently squeeze the gas lever.

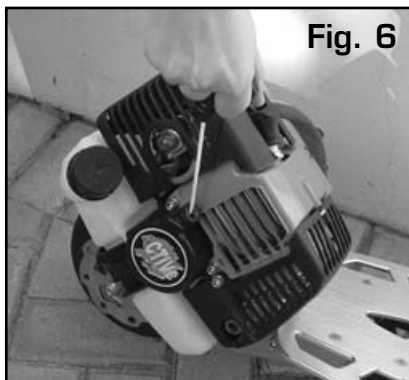

Fig. 6

**When starting the EVO Powerboard for the first time, it may be necessary to pull the starter handle 15-20 times until it starts.**

This is because the fuel needs to cycle into the engine.

16. Once the engine has started, quickly move the CHOKE LEVER into the RUN (DOWN) position. (Fig. 5).
17. After the engine is started, let it warm up for 2-3 minutes before riding.

**IF THE MOTOR KEEPS STALLING AT IDLE SPEED, IT MAY BE NECESSARY TO ADJUST THE IDLE SPEED ON THE CARBURETTOR.**

Please refer to **Carburettor Adjustment** in the Maintenance Section on Page 9 for Instructions on how to adjust idle speed.

18. Make sure that all of the exposed bolts and screws are tightened.
19. Raise the kickstand to its upright position.
20. Make sure the engine is running.
21. Put one foot on the deck of the EVO Powerboard. While pushing off with the other foot, gently depress the GAS LEVER, on the right side of the handlebars. The EVO Powerboard will begin to move on its own power.
22. Control your speed by pressing and releasing the accelerator lever. The harder you squeeze, the faster you will go.

### Braking

23. To brake, release the GAS LEVER and gently press the BRAKE LEVER.

## G.FOLDING AND STORAGE

When you are done riding the EVO Powerboard you can fold it down for compact storage, carrying and transportation. To fold down the EVO Powerboard, use one hand to push down on the folding handle while gently pushing down on the handlebars.

**BE CAREFUL NOT TO HIT YOUR HEAD WITH THE HANDLEBARS**  
Push down until you feel the mechanism lock into down position.



- **NOTE:** *If the lever is pulled aggressively, the locking spring may become stretched and then the steering will not lock into position, it is also advisable to ensure the evo powerboard locks firmly, prior to riding.*

You can now carry the EVO Powerboard by the handlebar tube.

## H.OPERATING PROCEDURES

### FUEL

#### WARNING!

- This is a 2-stroke engine. Only run the engine on fuel, which is properly mixed with 2-cycle engine oil.
- Provide good ventilation when fuelling or handling fuel.
- Always use gas with a minimum octane number of 93 unleaded.
- Use EVO/Active 2-stroke oil only (for Warranty Purposes).  
Mix 40:1 (Non-Synthetic oil) or 60:1 (Synthetic oil) (or 3%), gas:oil mixture.  
Refer to Fuel Mixture Table on page 8.
- Never use multi-grade (1 0W/30) or waste oil.
- Always mix fuel and oil in a separate clean, gas safe container. Always start by adding half the amount of fuel, which is to be used. Then add the whole amount of 2-cycle oil. Mix (shake) the fuel container. Add the remaining amount of fuel. Mix (shake) the fuel and oil thoroughly before filling the fuel tank.



## I. Fuel : Oil Mixing Table

Litres of Leaded Petrol	Oil Ratio (ml of oil)				
	POOR QUALITY OIL			BEST QUALITY OIL	
	20:1	30:1	40:1	50:1	60:1
<b>20 litres</b>	1 litre	660ml	500ml	400ml	330ml
<b>15 litres</b>	750ml	500ml	370ml	300ml	250ml
<b>10 litres</b>	500ml	330ml	250ml	200ml	160ml
<b>5 litres</b>	250ml	160ml	125ml	100ml	80ml
<b>1 litre</b>	50ml	30ml	25ml	20ml	16ml

\* Recommended with Good Quality 2-Stroke Oil i.e. TTS

\*\* Recommended with Fully Synthetic 2/5 Oil i.e. Motul 800 2T

### Fuelling

#### WARNING!

- Always shut the engine off before refuelling.
- Slowly open the fuel tank, so that possible over-pressure disappears.
- Before fuelling, clean the tank cap area carefully, to insure that no dirt falls into the tank. Make sure that the fuel is well mixed by shaking the container.
- Tighten the fuel cap carefully, after fuelling.
- Always move the unit at least 2 meters from the fuelling area before starting.

### Starting

- Set the CHOKE LEVER to the CHOKED (UP) position.
- Pull the recoil starter handle briskly, making sure to keep the handle in your grasp, and not allowing it to snap back.
- Once the engine is running, move the CHOKE LEVER to the RUN (Down) position.

#### NOTE!

At this stage, if the engine does not start, repeat the starting procedure.

- After starting the engine, allow the engine 2-3 minutes to warm up prior to riding.

### Stopping

- Gradually decrease the engine speed to an idle speed and press the kill-switch on the handlebar tube.
- If the Kill Switch malfunctions, choke the carburettor and depress the accelerator. The engine will stall immediately.

## J. MAINTENANCE

### RECOMMENDED TOOLS

To adjust and service the EVO Powerboard you will need the following tools:

- **Allen Keys:** 3/4/5/6mm
- **Wrenches:** 10/13/17mm - Open and Ring Combination
- **Short Reach Spark Plug Socket**
- **Water Pump Plier**
- **Philips Head Screwdrivers**
- **Oil, Grease or Lubricant**
- **EVO Toolkit is also available!!**

www.evopowerboards.com

## CARBURETTOR ADJUSTMENT

### **WARNING!**

***Never start the engine without the complete clutch cover assembled! Otherwise the clutch can come loose and cause personal injuries.***

In the Carburettor, fuel is mixed with air. When the engine is test run at the factory, the Carburettor is basically adjusted. A further adjustment may be required from time to time, depending on climate and altitude.

The Carburettor has three possible adjustments:

**P**=pilot adjustment screw

**M**=main jet adjustment screw

**T**=idle speed adjustment screw



### **Adjusting the Pilot Screw FIRST (Fig. 7):**

1. Hold the Throttle slide in the closed position and turn the Pilot Screw clockwise completely, then back one turn.
2. Start turning the screw slowly counter clockwise, until the powerboard stalls. Turn the screw then a quarter turn clockwise.
3. The scooter should start and idle easily.

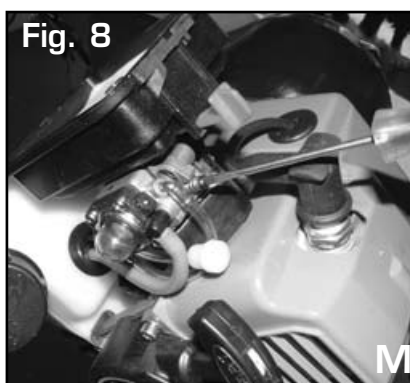

### **Adjusting the Main Jet Screw (Fig. 8):**

1. Place the Powerboard on a solid surface that enables the wheel to spin freely.
2. With the Powerboard engine warm, press the accelerator lever fully allowing the engine to rev.
3. With a small flat screwdriver turn the **main jet screw counter clockwise** until the engine runs **unsmoothly**.
4. Then turn the main jet screw clockwise until engine achieves maximum rpm.
5. Go 1/8 of a turn counter clockwise from max rpm.
6. This setting of this screw is sensitive to small increment changes.

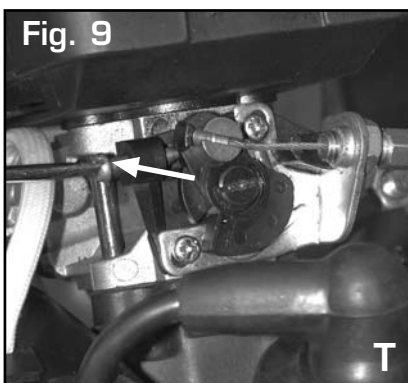

When the idle speed is adjusted properly, the engine will run smoothly, without pressing the GAS LEVER.

#### Adjusting the Idle Speed Screw:

1. Start the engine.
2. Using a long, Philips head screwdriver gently close (clockwise) the T-screw until the Big Boy Powerboard starts to move forward.
3. Then open (counter-clockwise) the screw until the EVO Powerboard stops.
4. You have reached the correct idle speed when the engine runs smoothly below the RPM when the EVO Powerboard starts to move.

#### WARNING!

When the engine is idling, under **NO CIRCUMSTANCES** should your **EVO Powerboard** be moving!!!

*If the EVO Powerboard continues to move after idle speed adjustment, contact your local EVO POWERBOARD Service Centre.*

#### Cleaning the Air Filter

It is a good idea to occasionally clean the air filter to ensure optimum performance. (Removal or Replacement of Airfilter other than original will automatically void warranty).



#### To clean the Air Filter:

1. Using a Philips head screwdriver, remove the carburettor cover by turning the cover screw counter clockwise. (Fig. 10).
2. Remove and clean the air filter (the spongy material on top of the air intake) by washing the sponge with soap and then leave to dry. (Fig. 11).
3. Rub the filter with some oil and place the air filter back into its original position and replace the cover.



## BRAKING SYSTEM

The EVO R Powerboard uses both a floating front wheel disc/calliper system activated by a hand lever on the handlebar. Familiarize yourself with the braking system before use. The front brake is activated by squeezing the BRAKE LEVER with your left hand. Make sure to release the GAS LEVER when engaging the brakes.

Practise braking on a smooth, dry surface to get used to the feel of the braking system. Braking distance is affected by wet conditions and loose and uneven riding surfaces.

### Adjusting the Brakes

The brakes on the EVO R Powerboard should come fully adjusted from the factory. However, it is important to adjust the brake from time to time.

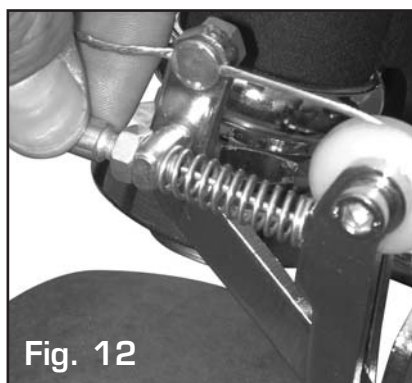

Fig. 12

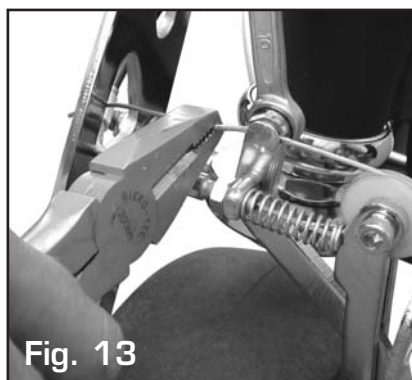

Fig. 13

#### To adjust the brakes:

1. With one hand, depress the brake calliper using your thumb and forefinger.
2. With the other hand, loosen the locknut (Fig. 12) of the tension screw on the brake line.
3. Turn the tension screw counter clockwise to tighten the brake.
4. Tighten cable freeplay until the front wheel stops turning freely and turn tension screw clockwise a quarter turn. The front wheel should turn freely now.
5. Turn the locknut clockwise on the tension screw to secure the tension screw. (DO NOT turn the tension screw!)
6. Once there is no more room for adjustment, the tension screw needs to be turned in all the way. The cable (Fig. 13) then needs to be pulled through the grub screw and be fastened. The freeplay can then again be taken up by the tension screw.

### Squeaky Brakes

The brakes may squeak before they are driven in. This is normal and will not affect the function or performance of the brakes. With continued use, the squeak should go away.

## TYRES AND WHEELS

The EVO R Powerboard uses an identical rim and tyre assembly on the front and rear wheels, which means that the tyres can be rotated. The wheels are actually two wheel halves (split rim) bolted together to make it easier to remove and replace the tyre and tube.

***Always make sure that the tyre is deflated before opening the bolts.***

The rear wheel is fitted with a special spacer to accommodate the belt pulleys, while the front wheel has a bracket for the disc brake.

Tyre wear will differ based on rider weight, riding conditions and care. Replacement tyres can be obtained at your local EVO Powerboard Dealer or from the EVO Website at: [www.evopowerboards.com](http://www.evopowerboards.com)

### Tyre Pressure

The tyre must be inflated between 2 and 2,5 Bar. It is also recommended to use a tube additive like Slime purchasable from any motorcycle shop, to avoid inconvenient punctures. Empty all air from the tyre, prior to loosening the bolt to split the rim.

### ADJUSTING THE HEAD UNIT (steering tube)

The head unit should come adjusted from the factory. However, riding on rough terrain and general use may cause the head unit to become loose over time. It may be necessary to adjust the head unit from time to time.

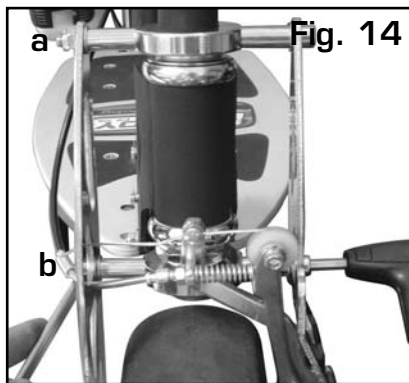

Fig. 14

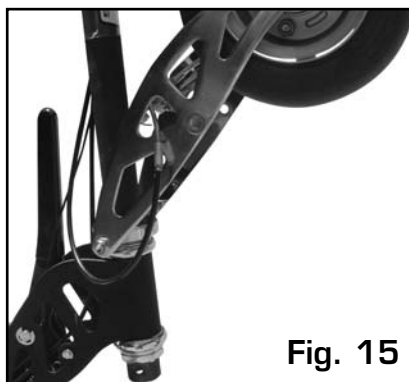

Fig. 15

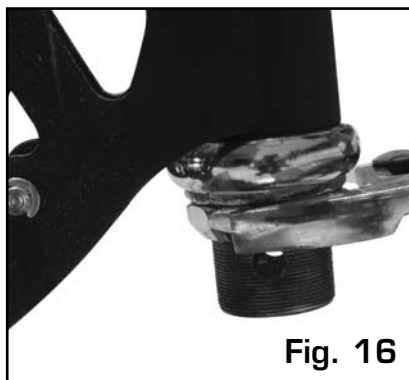

Fig. 16

#### To adjust the head unit:

1. Loosen (a) and Remove the long bolt (b) shown on Fig. 14.
2. Rotate the complete front wheel and fork assembly upwards so that the large bearing lock nuts are accessible (Fig. 15).
3. Using 2 large adjustable wrenches, loosen both nuts (Fig. 16).
4. Tighten the nut closest to the bearing to the desired tightness. The handlebar should still be able to turn freely however with no backwards and forwards freeplay.
5. Then securing the 1st nut, tighten the 2nd nut against the first insuring it is locked securely.
6. Lower complete wheel and fork assembly and place bolt and bushes in same order as disassembly.
7. Ensure that top and bottom bolts are tightened.

\* **NB!! DO NOT OVER TIGHTEN OR IT WILL DAMAGE THE BEARINGS!!**

\* **DO NOT CONTINUE TO USE PRODUCT IF THERE IS TOO MUCH FREE PLAY AS THIS WILL DAMAGE THE BEARINGS!!!**

## ADJUSTING THE BELT AND CHAIN

The belt and chain will come adjusted from the factory. However, it may be necessary to adjust the pulleys from time to time. The belt and chain must be well aligned onto the pulleys otherwise they may start to rub and chafe, which will result in shortened belt and chain life.

### How tight should the belt be?

- If the belt is skipping or jumping on the pulley teeth, this is too loose and may be harmful.
- If the belt is making a humming sound when the wheel is turning, this is too tight and may cause the belt to snap.
- The correct tension is achieved by adjusting the belt from its loose position to when it becomes lightly tense.

### How tight should the chain be?

- The chain should have between 3 - 5mm free play in the centre between the two sprockets.
- If a grinding noise is heard the chain is either incorrectly aligned or too tight and this can cause damage to both the chain and sprockets.
- If the chain keeps coming off, the chain is too loose and must be adjusted.

### NB!! IMPORTANT TO LUBRICATE CHAIN PRIOR TO USE DAILY!

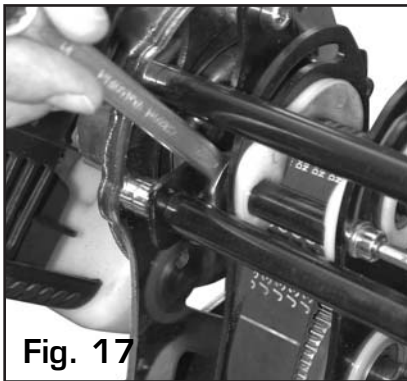

Fig. 17



Fig. 18

#### To tighten the belts:

1. Remove the mud guard.
2. Remove the rear wheel to assess the alignment of the belt and chain.

#### Adjust the Belt First:

3. Loosen the tensioned lock nut on the cam slotted plate (Fig. 17).
4. Rotate the bush until the correct tension is achieved, making sure to turn the wheel in direction of use to ensure bush is correctly seated and aligned. Tighten bolt again ensuring position of bush is maintained.

#### Adjust the Chain Now:

5. Collapse the powerboard and position the unit upside down on the handlebars (Fig. 18).

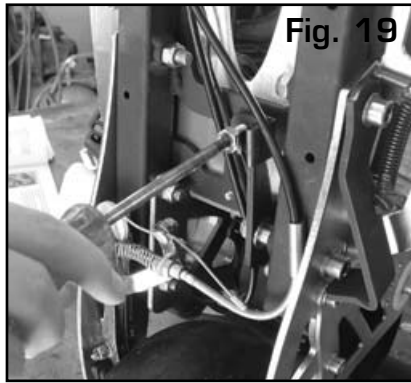

6. With both spanner and allen key, adjust the tension (Fig. 19).
7. Ensure that the lock nut is securely fastened against the plate. If this is not done correctly, the chain will loosen immediately and there is a possibility of losing the bolt.

## MAINTENANCE SCHEDULE

Proper care of your Powerboard will ensure optimal performance and longer life span. The following are a few maintenance suggestions that will keep your EVO Powerboard running in top condition:

### Daily Maintenance

Perform each time you ride your EVO Powerboard.

- Clean the exterior of the unit with a soft, damp rag.
- Check that all nuts and bolts are securely tightened.
- Lubricate the chain with a proper chain lubricant.

### Weekly/Monthly Maintenance

- Check the starter, especially the cord and return spring.
- Clean the exterior of the spark plug.
- Remove the spark plug and check the electrode gap. Adjust it to 0.6mm or change the spark plug.
- Clean the cooling fins on the cylinder head and check that the air intake at the starter is not clogged.
- Clean the air filter.
- Check tyres and brakes.

## K. OTHER QUESTIONS

For additional questions, service instructions, further information and important phone numbers, please go to your EVO Powerboard Dealer.

## **EVO POWERBOARDS LIMITED WARRANTY INFORMATION**

Evo Powerboards warrants this Product against defects in material or workmanship as follows:

**1. Labour:** For a period of **3 months** from the date of purchase, if this Product is determined to be defective, EVO Powerboards will repair the Product at no charge or pay the labour charges to any EVO Authorized Service Facility. After the Warranty Period, you must pay for all labour charges.

**2. Parts:** In addition, EVO will supply, at no charge, new or rebuilt replacement parts in exchange for defective parts for a period of **3 months**. After 6 months from the date of purchase, labour for removal and installation is available from EVO Authorized Service Facilities at YOUR expense.

**To obtain warranty service, you must take the Product, or deliver the Product freight prepaid, in either its original packaging or packaging affording equal degree of protection, to any Authorized EVO Service Facility.**

**Proof of purchase in the form of a bill of sale or receipted invoice, which is evidence that the unit is within the Warranty Period, must be presented to obtain warranty service.**

This warranty does not cover customer instruction, set-up adjustments or Product modification outside of the original factory configuration.

It is strongly recommended to only use EVO Approved makes of oil and parts!

The warranty does not cover cosmetic damage or damage due to acts of God, accidents, misuse, abuse, negligence, commercial use, or modification of, or to any part of the Product, including the motor and batteries. This warranty does not cover damage due to improper fuel or engine oil mixture or attempted repair by anyone other than a facility authorized by EVO to service this product. This warranty does not cover products sold AS IS or WITH ALL FAULTS. This warranty is valid only in USA.

This warranty is invalid if the factory-applied serial number has been altered or removed from this Product.

*REPAIR OR REPLACEMENT AS PROVIDED UNDER THIS WARRANTY IS THE EXCLUSIVE REMEDY OF THE CONSUMER. EVO SHALL NOT BE LIABLE FOR ANY INCIDENTAL OR CONSEQUENTIAL DAMAGES FOR BREACH OF ANY EXPRESSED OR IMPLIED WARRANTY ON THIS PRODUCT. EXCEPT TO THE EXTENT PROHIBITED BY APPLICABLE LAW, ANY IMPLIED WARRANTY OR MERCHANTABILITY OR FITNESS FOR PARTICULAR PURPOSE ON THIS PRODUCT IS LIMITED IN DURATION TO THE DURATION OF THIS WARRANTY.*

*Some states do now allow the exclusion or limitations of incidental or consequential damages, or allows limitation on how long an implied warranty lasts, so the above limitation or exclusions may not apply to you. In addition, if you purchase an extended service policy, these limitations may also not pertain to you. This warranty gives you specific legal rights, and you may have other rights, which vary from state to state.*